

Inlet filter, ECO design, front- or rear side mounting, protection class I or II

Standard- or Medical-Filter



new

Snap-in mounting from front side
Protection class II**Description**

- Panel Mount:
Screw-on version from front or rear side, snap-in version from front side
- 2 Functions:
Inlet, protection class I or II, Line filter in standard and medical version
Quick connect terminals 6.3 x 0.8 mm

Approvals

- VDE License Number: 40016382
- UL License Number: E72928

Characteristics

- Compact high performance filter
- Optimal shielding due to completely closed filter case, unpotted
- Designed for standard and medical applications
- Suitable for assembly in metal plated plastic housings
- Qualified for use in equipment according IEC/EN 60950

Other versions on request

- Snap-in for panel thickness >2mm to 3mm
- Solder terminals
- Class X1 capacitor for enhanced surge withstand voltage
- Medical version M80

References

[General Product Information](#)

Weblinks

[Approvals](#), [RoHS](#), [CHINA-RoHS](#), [e-Store](#), [SCHURTER-Stock-Check](#), [Distributor-Stock-Check](#)

Technical Data

Ratings IEC	1 - 10A @ Ta 40 °C / 250VAC; 50Hz	Appliance-Inlet/-Outlet	C14/C18 acc. to IEC/EN 60320-1, UL 498, CSA C22.2 no. 42 (for cold conditions) pin-temperature 70 °C, 10A, Protection class I or II
Ratings UL/CSA	1 - 15A @ Ta 40 °C / 250VAC; 60Hz	Line Filter	Standard and Medical Version, IEC 60939, IEC 60601-1, UL 1283, UL 544, EN 133 200, CSA C22.2 no. 8 Technical details
Leakage Current	standard < 0.5mA (250V / 60Hz) medical < 5 µA (250V / 60Hz)	MTBF	> 3'000'000h acc. to MIL-HB-217 F
Dielectric Strength	> 1.7kVDC between L-N > 2.7kVDC between L/N-PE Test voltage (2sec)		
Allowable Operation Temp.	-25°C to 85°C		
Climatic Category	25/085/21 acc. to IEC 60068-1		
Degree of Protection	from front side IP 40 acc. to IEC 60529		
Protection Class	Suitable for appliances with protection class I or II acc. to IEC 61140		
Terminal	Quick connect terminals 6.3 x 0.8 mm		
Panel Thickness s	Screw-on: max 8 mm Mounting screw torque max 0.5Nm Snap-in: 0.8mm to 2 mm (all steps with one variant)		
Material: Housing	Themoplast / steel tin-plated, black / metallic, UL 94V-0		

Dimensions

Length  54.5 mm

Front or rear side mounting for screws with nuts or blind rivets (panel cutout for frontside mounting)

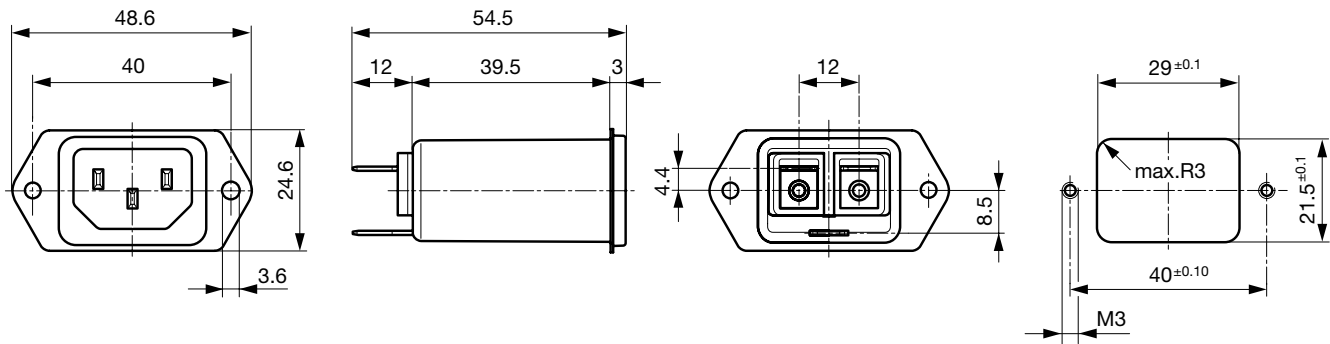

Rear side mounting with pre-formed, threaded holes for M3 screws (panel cutout for rear side mounting)

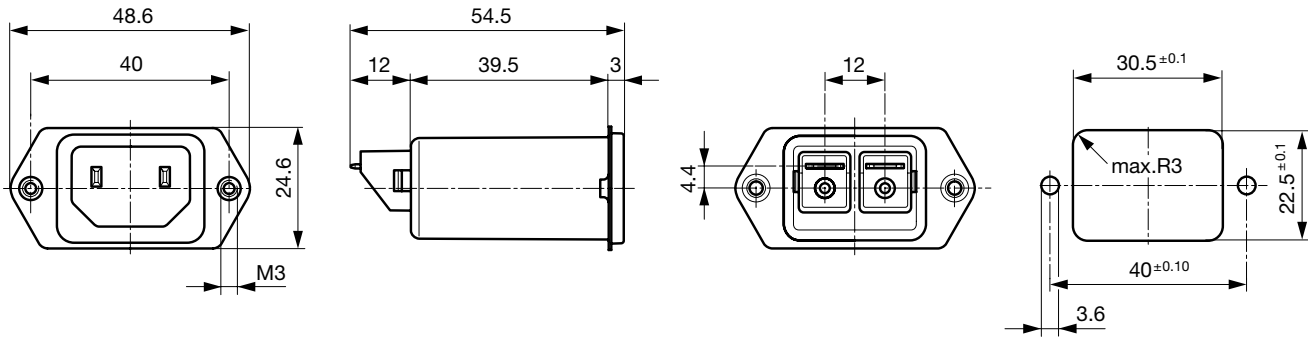

Dimensions for class II version also apply to class I

Snap-in mounting from front side

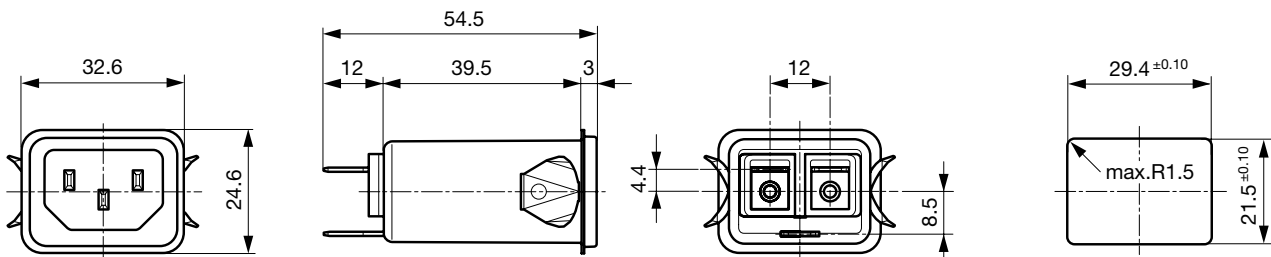

Dimensions for class I version also apply class II

Technical Data of Filter-Components

Rated Current [A]	Filter-Type	Inductances L [mH]	Capacitance CX [nF]	Capacitance CY [nF]	R [MΩ]
1	Standard Version	2 x 12	100	2.2	-
2	Standard Version	2 x 5.2	100	2.2	-
4	Standard Version	2 x 2	100	2.2	-
6	Standard Version	2 x 0.8	100	2.2	-
10	Standard Version	2 x 0.4	100	2.2	-
15	Standard Version	2 x 0.1	100	2.2	-
1	Bleed Resistor Version	2 x 12	100	2.2	1
2	Bleed Resistor Version	2 x 5.2	100	2.2	1
4	Bleed Resistor Version	2 x 2	100	2.2	1
6	Bleed Resistor Version	2 x 0.8	100	2.2	1
10	Bleed Resistor Version	2 x 0.4	100	2.2	1
15	Bleed Resistor Version	2 x 0.1	100	2.2	1
1	Medical Version (M5)	2 x 12	100	-	1
2	Medical Version (M5)	2 x 5.2	100	-	1
4	Medical Version (M5)	2 x 2	100	-	1
6	Medical Version (M5)	2 x 0.8	100	-	1
10	Medical Version (M5)	2 x 0.4	100	-	1
15	Medical Version (M5)	2 x 0.1	100	-	1

Diagrams

Standard version

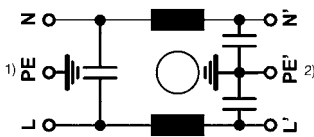

1) Line
2) Load

Bleed resistor version

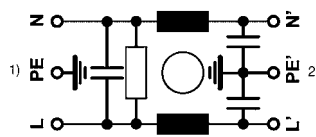

1) Line
2) Load

Medical version M5

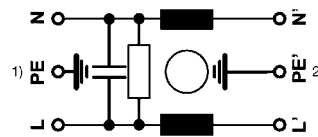

1) Line
2) Load

Medical version M5, prot. class II

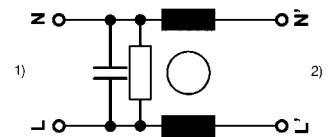

1) Line
2) Load

Attenuation Loss

--- differential mode _____ common mode

Standard version

1 A

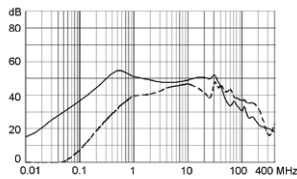

2 A

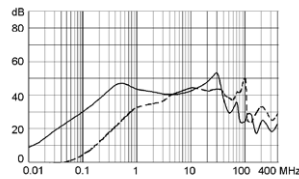

4 A

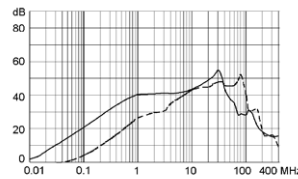

6 A

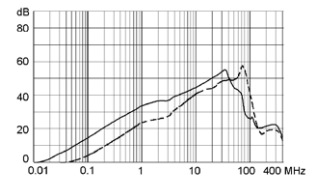

10 A

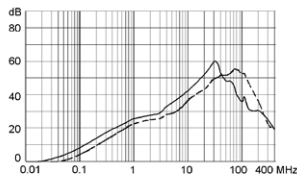

15 A

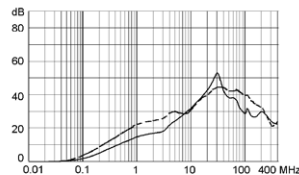

Medical version (M5)

1 A

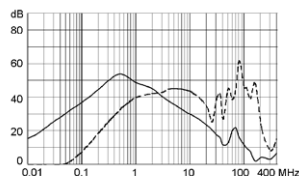

2 A

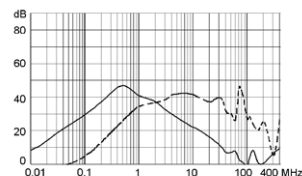

4 A

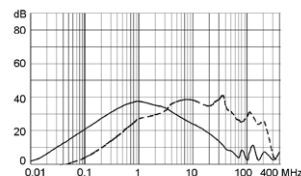

6 A

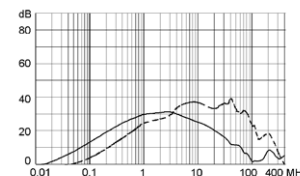

10 A

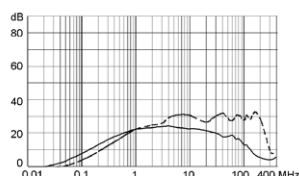

15 A

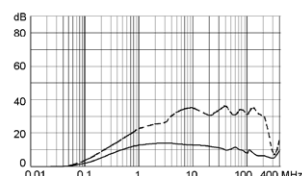

Variants

[Distributor-Stock-Check](#) | [SCHURTER-Stock-Check](#) | [e-Store](#)

Rated Current [A]	Filter-Type	Panel mounting	Mounting side	Protection Class	Order Number
1	Standard Version	Screw-on/Rivet	Front-/Rear-Side	I	5120.0000.0
2	Standard Version	Screw-on/Rivet	Front-/Rear-Side	I	5120.0001.0
4	Standard Version	Screw-on/Rivet	Front-/Rear-Side	I	5120.0003.0
6	Standard Version	Screw-on/Rivet	Front-/Rear-Side	I	5120.0004.0
10	Standard Version	Screw-on/Rivet	Front-/Rear-Side	I	5120.0006.0
15	Standard Version	Screw-on/Rivet	Front-/Rear-Side	I	5120.0007.0
1	Standard Version	Snap-in	Front-Side	I	5120.2000.0
2	Standard Version	Snap-in	Front-Side	I	5120.2001.0
4	Standard Version	Snap-in	Front-Side	I	5120.2003.0
6	Standard Version	Snap-in	Front-Side	I	5120.2004.0
10	Standard Version	Snap-in	Front-Side	I	5120.2006.0
15	Standard Version	Snap-in	Front-Side	I	5120.2007.0
1	Standard Version	Screw-on	Rear-Side	I	5120.1000.0
2	Standard Version	Screw-on	Rear-Side	I	5120.1001.0
4	Standard Version	Screw-on	Rear-Side	I	5120.1003.0
6	Standard Version	Screw-on	Rear-Side	I	5120.1004.0
10	Standard Version	Screw-on	Rear-Side	I	5120.1006.0
15	Standard Version	Screw-on	Rear-Side	I	5120.1007.0
1	Bleed Resistor Version	Screw-on/Rivet	Front-/Rear-Side	I	5120.0200.0
2	Bleed Resistor Version	Screw-on/Rivet	Front-/Rear-Side	I	5120.0201.0
4	Bleed Resistor Version	Screw-on/Rivet	Front-/Rear-Side	I	5120.0203.0
6	Bleed Resistor Version	Screw-on/Rivet	Front-/Rear-Side	I	5120.0204.0
10	Bleed Resistor Version	Screw-on/Rivet	Front-/Rear-Side	I	5120.0206.0
15	Bleed Resistor Version	Screw-on/Rivet	Front-/Rear-Side	I	5120.0207.0
1	Bleed Resistor Version	Snap-in	Front-Side	I	5120.2200.0
2	Bleed Resistor Version	Snap-in	Front-Side	I	5120.2201.0
4	Bleed Resistor Version	Snap-in	Front-Side	I	5120.2203.0
6	Bleed Resistor Version	Snap-in	Front-Side	I	5120.2204.0
10	Bleed Resistor Version	Snap-in	Front-Side	I	5120.2206.0
15	Bleed Resistor Version	Snap-in	Front-Side	I	5120.2207.0
1	Bleed Resistor Version	Screw-on	Rear-Side	I	5120.1200.0
2	Bleed Resistor Version	Screw-on	Rear-Side	I	5120.1201.0
4	Bleed Resistor Version	Screw-on	Rear-Side	I	5120.1203.0
6	Bleed Resistor Version	Screw-on	Rear-Side	I	5120.1204.0
10	Bleed Resistor Version	Screw-on	Rear-Side	I	5120.1206.0

Rated Current [A]	Filter-Type	Panel mounting	Mounting side	Protection Class	Order Number
15	Bleed Resistor Version	Screw-on	Rear-Side	I	5120.1207.0
1	Medical Version (M5)	Screw-on/Rivet	Front-/Rear-Side	I	5120.0300.0
2	Medical Version (M5)	Screw-on/Rivet	Front-/Rear-Side	I	5120.0301.0
4	Medical Version (M5)	Screw-on/Rivet	Front-/Rear-Side	I	5120.0303.0
6	Medical Version (M5)	Screw-on/Rivet	Front-/Rear-Side	I	5120.0304.0
10	Medical Version (M5)	Screw-on/Rivet	Front-/Rear-Side	I	5120.0306.0
15	Medical Version (M5)	Screw-on/Rivet	Front-/Rear-Side	I	5120.0307.0
1	Medical Version (M5)	Snap-in	Front-Side	I	5120.2300.0
2	Medical Version (M5)	Snap-in	Front-Side	I	5120.2301.0
4	Medical Version (M5)	Snap-in	Front-Side	I	5120.2303.0
6	Medical Version (M5)	Snap-in	Front-Side	I	5120.2304.0
10	Medical Version (M5)	Snap-in	Front-Side	I	5120.2306.0
15	Medical Version (M5)	Snap-in	Front-Side	I	5120.2307.0
1	Medical Version (M5)	Screw-on	Rear-Side	I	5120.1300.0
2	Medical Version (M5)	Screw-on	Rear-Side	I	5120.1301.0
4	Medical Version (M5)	Screw-on	Rear-Side	I	5120.1303.0
6	Medical Version (M5)	Screw-on	Rear-Side	I	5120.1304.0
10	Medical Version (M5)	Screw-on	Rear-Side	I	5120.1306.0
15	Medical Version (M5)	Screw-on	Rear-Side	I	5120.1307.0
1	Medical Version (M5)	Screw-on/Rivet	Front-/Rear-Side	II	5120.0300.1
2	Medical Version (M5)	Screw-on/Rivet	Front-/Rear-Side	II	5120.0301.1
4	Medical Version (M5)	Screw-on/Rivet	Front-/Rear-Side	II	5120.0303.1
6	Medical Version (M5)	Screw-on/Rivet	Front-/Rear-Side	II	5120.0304.1
10	Medical Version (M5)	Screw-on/Rivet	Front-/Rear-Side	II	5120.0306.1
15	Medical Version (M5)	Screw-on/Rivet	Front-/Rear-Side	II	5120.0307.1
1	Medical Version (M5)	Snap-in	Front-Side	II	5120.2300.1
2	Medical Version (M5)	Snap-in	Front-Side	II	5120.2301.1
4	Medical Version (M5)	Snap-in	Front-Side	II	5120.2303.1
6	Medical Version (M5)	Snap-in	Front-Side	II	5120.2304.1
10	Medical Version (M5)	Snap-in	Front-Side	II	5120.2306.1
15	Medical Version (M5)	Snap-in	Front-Side	II	5120.2307.1
1	Medical Version (M5)	Screw-on	Rear-Side	II	5120.1300.1
2	Medical Version (M5)	Screw-on	Rear-Side	II	5120.1301.1
4	Medical Version (M5)	Screw-on	Rear-Side	II	5120.1303.1
6	Medical Version (M5)	Screw-on	Rear-Side	II	5120.1304.1
10	Medical Version (M5)	Screw-on	Rear-Side	II	5120.1306.1
15	Medical Version (M5)	Screw-on	Rear-Side	II	5120.1307.1

- 15 A version only according UL/CSA

- Type for screw-on mounting from rear side has pre-threaded holes for M3 screws

Packaging unit 10 Pcs

Accessory

Description



Assorted Covers
Rear Cover

0859.0048



Cord retaining kits
Cord retaining strain relieve

Flat head, Z

0888.0021

Flat head, E

4700.0005

Flat head, G

4700.0007